

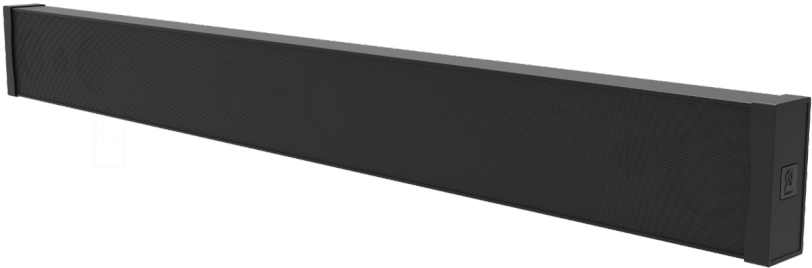

SOUNDBARS

Installation Manual



SBR41 | SBR41-LCR | SBR43-50 |
SBR43-55 | SBR43-60 | SBR43-65 | SBR43-70
SBR43-75 | SBR43-80 | SBR43-85





Table of Contents

Introduction	1
Soundbar Specifications	2
What's Included	4
Soundbar Line Drawings	5
Soundbar Mounting Steps	6
Extending the Soundbar to Match TV Length	10
Wiring Connection	13
Finalizing the Installation	15
Perfectioning the Sound	15
Troubleshooting	16
Technical Assistance	17
Warranty Coverage - 5 Year Limited Warranty	18
Return Process	19

Introduction

Thank you for choosing an Origin Soundbar. The Soundbar is a passive speaker system. The SBR41 & SBR41-LCR are single channel enclosures that can be placed on the Left, on the Right, or in the Center above & below the video display. Three speakers can also be placed in a linear row above or below the video display. The rest of the SBR43-50 to SBR43-85 models contain all three channels, Left, Center and right.

The drivers are mounted in extruded aluminum enclosures and can be mounted on the wall or attached to a third-party mount connected directly to the video display. Regardless of your choice of mounting and position, the Soundbars will deliver pristine music and movie soundtracks and compliment your home theater experience.

This Soundbar range has been specially developed to extend and be adjusted in order to exact match any specific model of TV for the ideal visual symmetry within the space.

This instruction booklet cover the necessary information for a smooth installation, including: the tools you will need, step-by-step instructions for installation, troubleshooting tips for any errors that may occur, and all warranty information. If for any reason you experience problems or if you have installation questions please call us at (844) 674-4461. Hours of operation are 8:00am to 5:00pm (Pacific Time), Monday through Friday.

Soundbar Specifications

SPECIFICATION	ALL MODELS
Woofers	3 1/2" Fiber Glass
Tweeter	1" Silk DPSD™
Frequency Response	65Hz - 20kHz
Impedance	4 Ω per Channel
Power RMS	75 Watts
Power Peak	150 Watts
Sensitivity	90 dB
Enclosure	Aluminum Cabinet

MODEL	CHANNELS
SBR41	1
SBR41-LCR	1
SBR43-50	3
SBR43-55	3
SBR43-60	3
SBR43-65	3
SBR43-70	3
SBR43-75	3
SBR43-80	3
SBR43-85	3

MODEL	PART	DIMENSIONS
SBR41	SBR41000	11 ⁵⁷ / ₆₄ " L x 6" H x 2 ⁹ / ₁₆ " D [302 L x 152 H x 65 D mm]
SBR41-LCR	SBR41LCR	16 ⁷ / ₆₄ " L x 6" H x 2 ⁹ / ₁₆ " D [409 L x 152 H x 65 D mm]
SBR43-50	SBR43500	42 ¹ / ₈ " L x 6" H x 2 ⁹ / ₁₆ " D [1070 L x 152 H x 65 D mm]
SBR43-55	SBR43550	48 ¹⁵ / ₆₄ " L x 6" H x 2 ⁹ / ₁₆ " D [1225 L x 152 H x 65 D mm]
SBR43-60	SBR43600	52 ²³ / ₃₂ " L x 6" H x 2 ⁹ / ₁₆ " D [1339 L x 152 H x 65 D mm]
SBR43-65	SBR43650	56 1/2" L x 6" H x 2 ⁹ / ₁₆ " D [1435 L x 152 H x 65 D mm]
SBR43-70	SBR43700	60 ⁵³ / ₆₄ " L x 6" H x 2 ⁹ / ₁₆ " D [1545 L x 152 H x 65 D mm]
SBR43-75	SBR43750	65 ⁵ / ₃₂ " L x 6" H x 2 ⁹ / ₁₆ " D [1655 L x 152 H x 65 D mm]
SBR43-80	SBR43800	69 ³¹ / ₆₄ " L x 6" H x 2 ⁹ / ₁₆ " D [1765 L x 152 H x 65 D mm]
SBR43-85	SBR43850	74 ¹ / ₆₄ " L x 6" H x 2 ⁹ / ₁₆ " D [1880 L x 152 H x 65 D mm]



*All product specifications are subject to change. Please refer to the dealer portal for the latest information.

What's Included

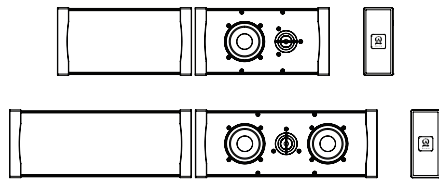
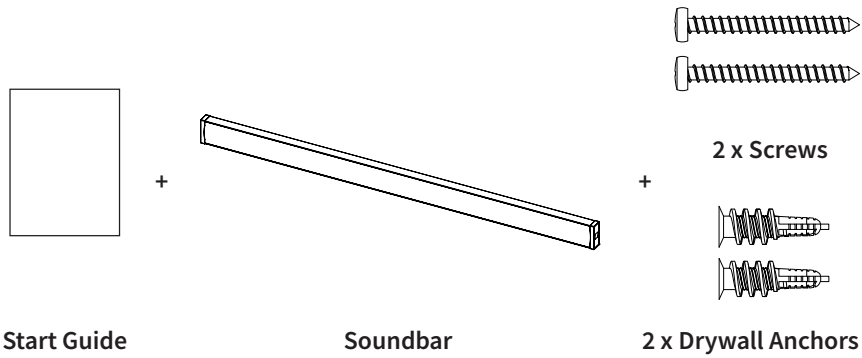

SBR41 / SBR41-LCR WITH 1 SPEAKER

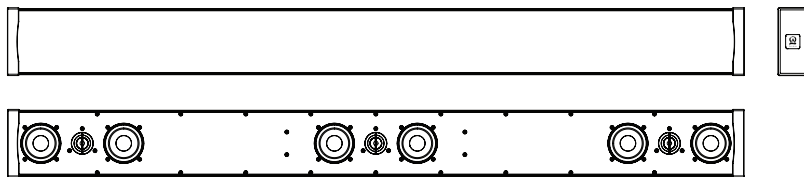

SBR43-50 TO SBR43-85 WITH 3 SPEAKERS

Soundbar Line Drawings

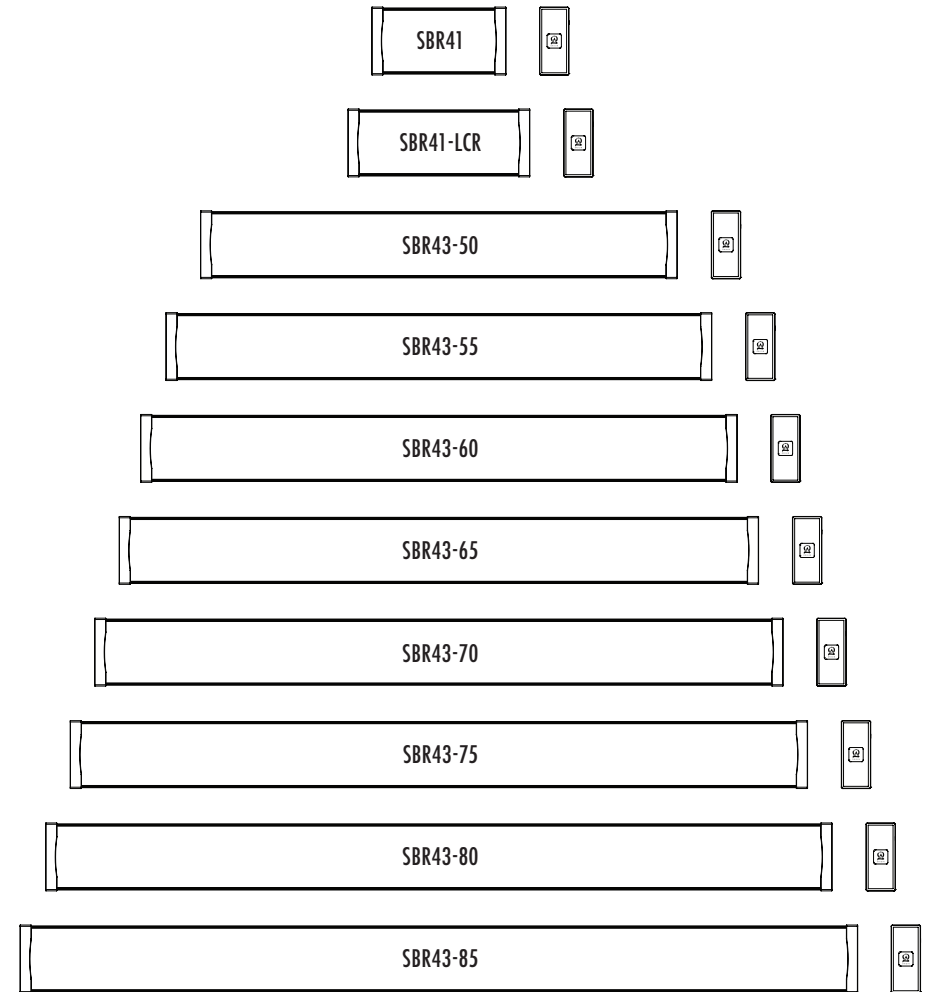

Soundbar Mounting Steps

The first step in mounting the Soundbar is to determine the optimum position based on the room parameters and your television location.

Care must be taken to ensure the soundbar is mounted securely.

It is best to check the angle of the television and use that line as a guide to avoid the appearance that the soundbar is mounted misaligned. Be advised that there are several relative angles in the room that may not be square. Use a level to establish the ideal position based on gravity.

NOTE: The soundbars use a keyhole mounting system (*See Diagrams 1, 2A & 2B*).

The Soundbar will slide down 3/8" below the template location, until the screw rests at the uppermost position in the mounting element. Take this into account when marking screw holes.

Make sure there is enough room to accommodate the soundbar in the selected location.

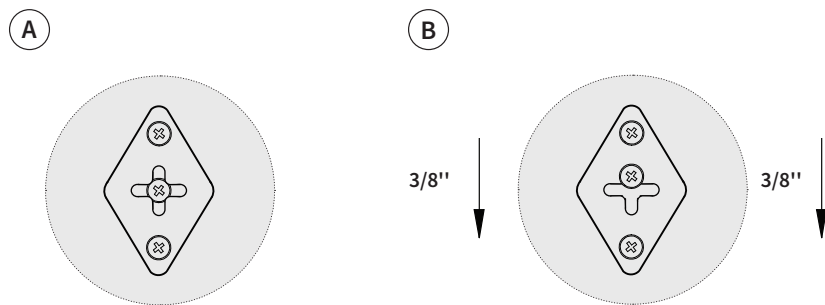

Diagram 1

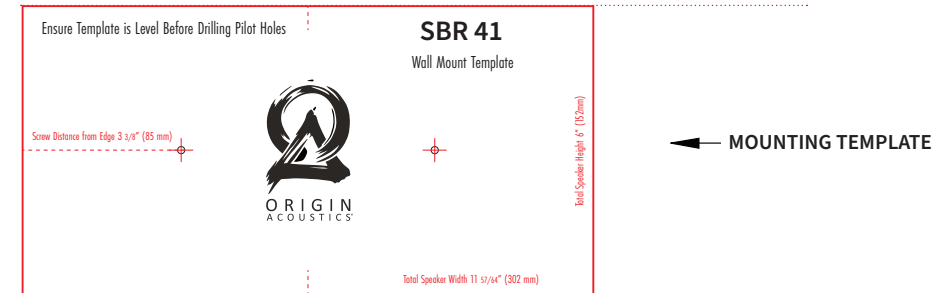

Diagram 2A

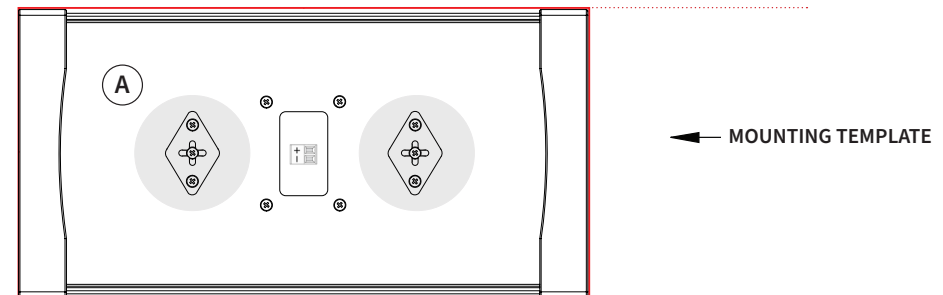
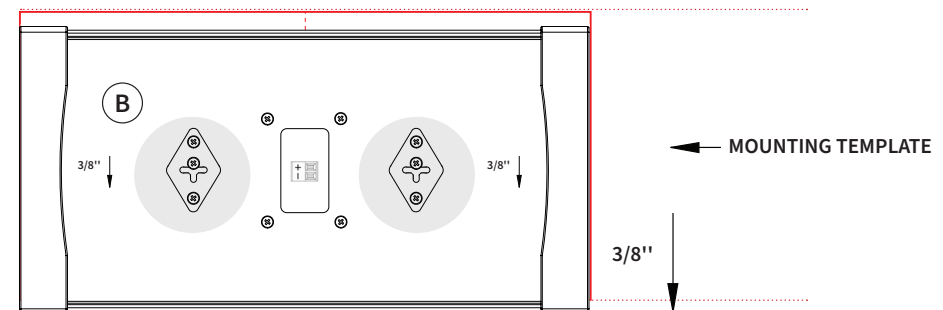

Diagram 2B



Mounting Steps continued. . .

Once the position has been established, place the included template in the desired location (*See Diagrams 3 & 4*):

1. Making sure the position lines up with the television,
2. Secure the template with masking tape on the wall.
3. Mark the final screw position on the wall with a sharp tool or a tack.
4. Remove the template from the wall.
5. Drive in the screws using a screwdriver. Use the appropriate mounting: you will either use wood screws or drywall anchors to secure the soundbar behind the drywall.
6. Make sure when tightening the screws that enough space is allowed for the mounting element to slide over the head of the screw and into its final position. This may require a bit of adjustment to securely position the speaker against the wall. Once the mounting has been tested, remove the speaker from the wall. A hole must now be drilled into the wall to allow for the speaker wires to pass through, making sure the hole is large enough for all three wires to pass through. (*See Diagrams 6 & 7*)

Diagram 3 | SBR41 & SBR41-LCR MOUNTING OPTIONS

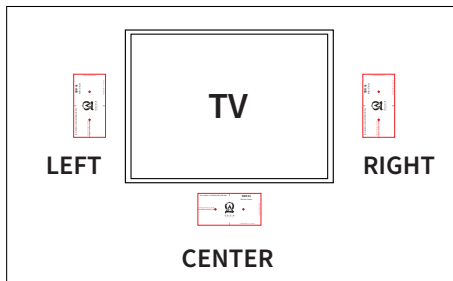
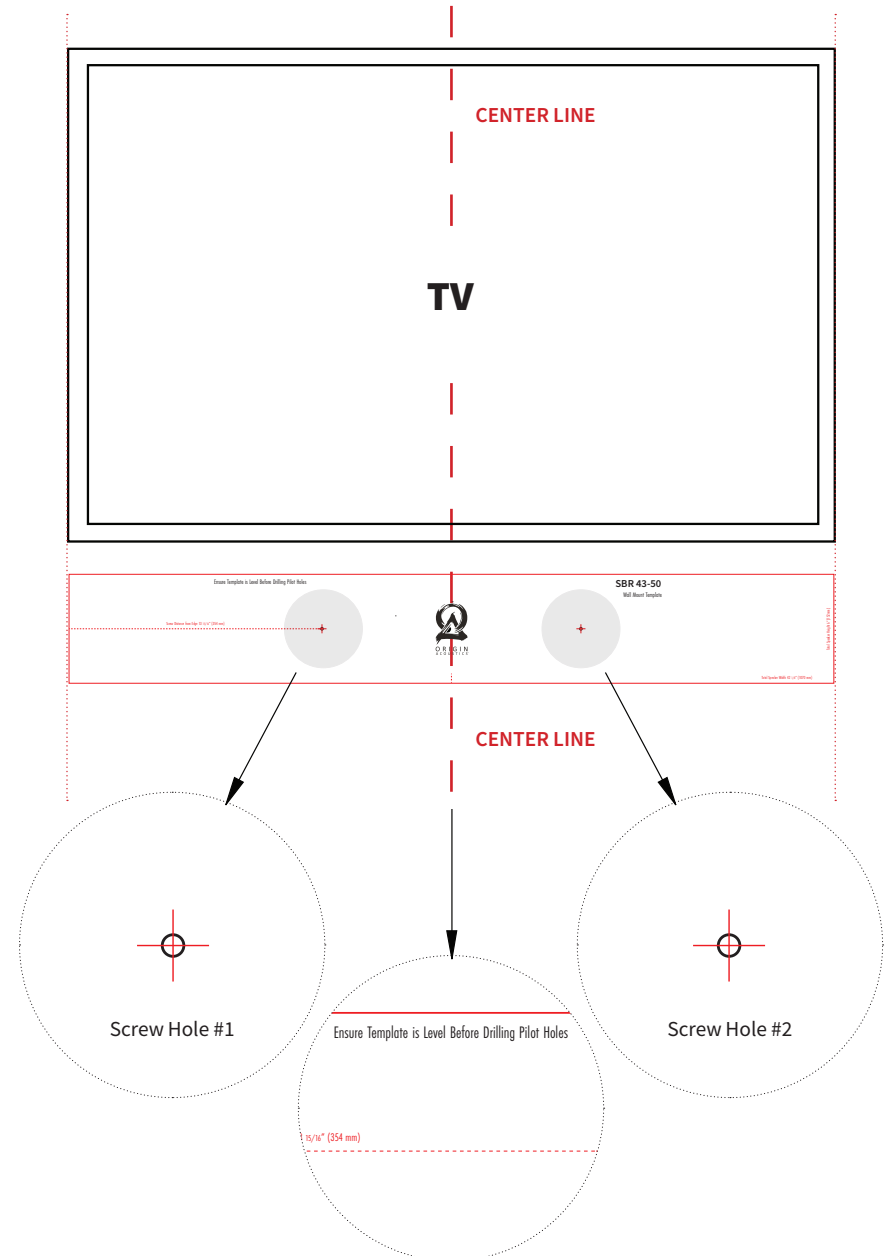

Diagram 4 | SBR43-50 TO SBR43-85 MOUNTING PLACEMENT



Extending the Soundbar to Match TV Length

To perfectly align to the TV length, each soundbar can be extended by 1", before securing to the wall. This is done by extending the screw caps by up to 1/2 inch on each end of the soundbar. Make sure to center the screws on the wall before you prepare to extend the soundbar. Take off the logo-engraved magnetic cover, on each end-cap, and use a drill, to loosen the the two screws on each end of the Soundbar:

Making Small Length Adjustments:

1. Once the logo-engraved cover is off (*See Diagram 5*), use the a drill with a phillips head, anticlockwise, to loosen & extend the sounbar end-cap. Several possible adjustments can be made to provide the best match to the exact TV length.
2. Alternate adjustments between the 2 screws, to make sure the angles of the end caps stay parallel.
3. Once extended fully, each end cap will reach an additional 1/2", if a longer length adjustment is desired, take off the second end cap, and repeat the process to reach an addition 1/2" length in size.

To shorten the length, use the drill, clockwise, to re-righten the cap.

Diagram 5

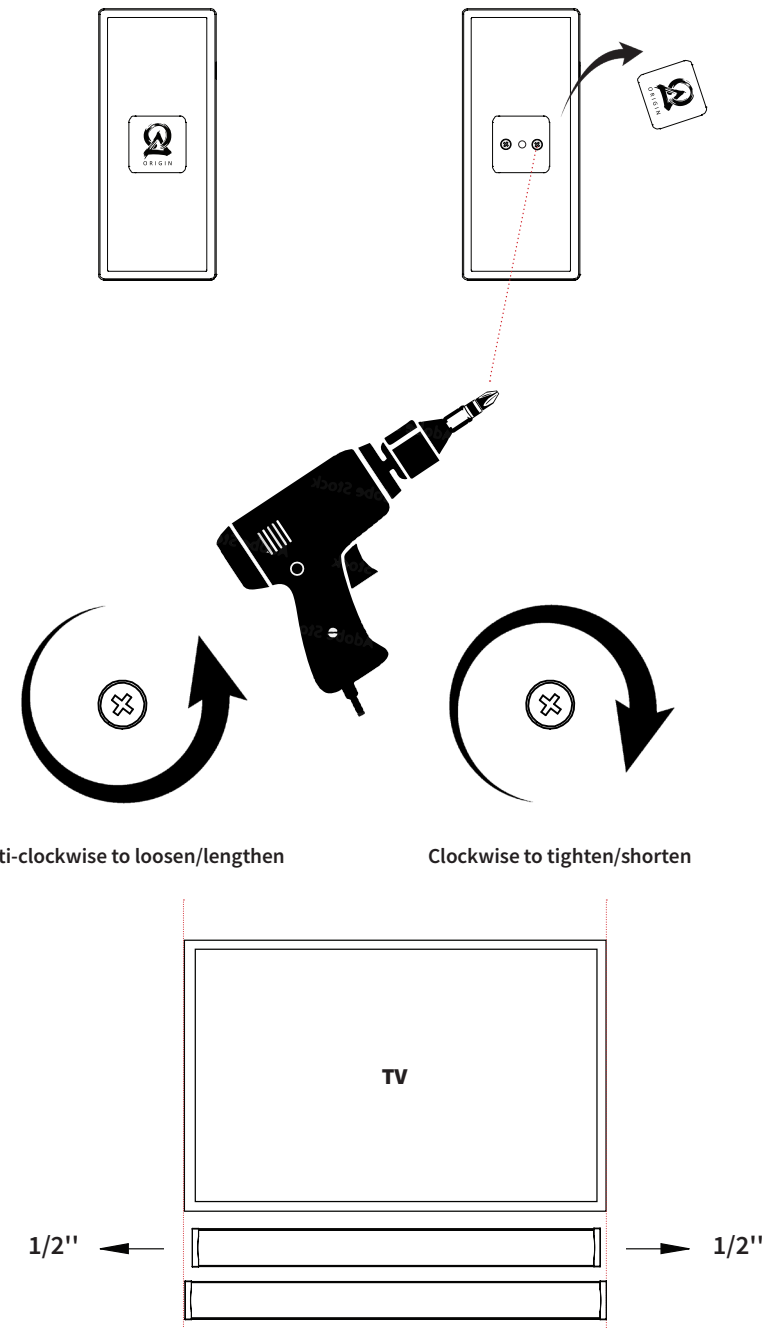
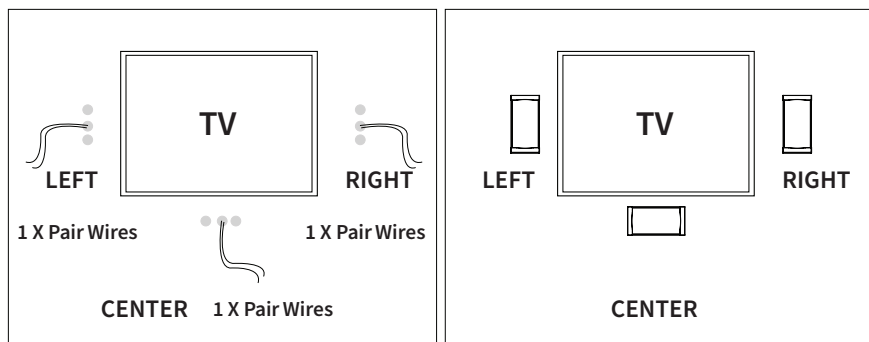
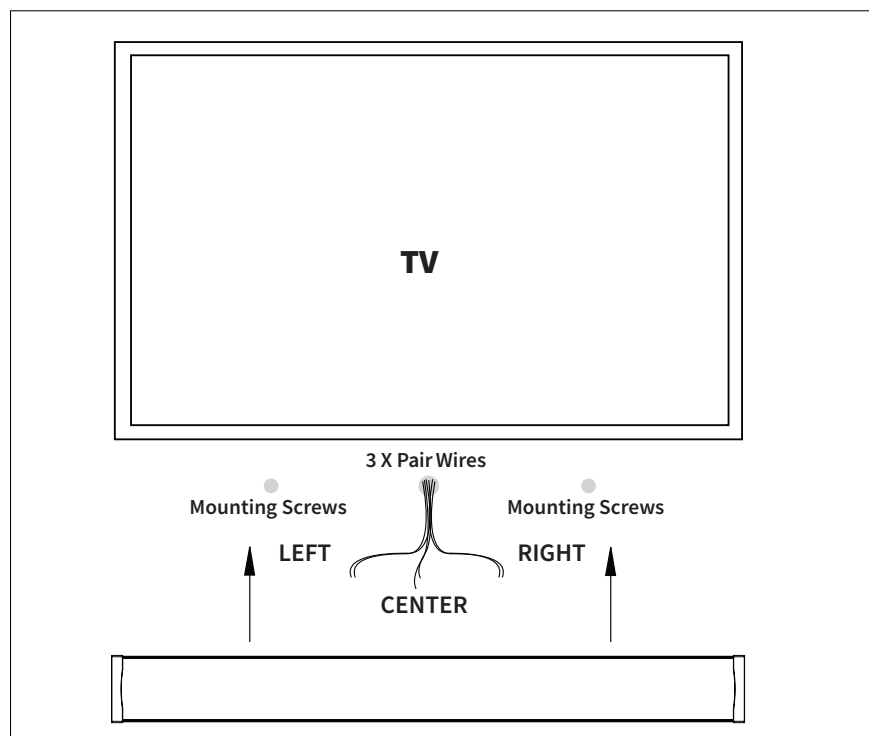

Diagram 6 | SBR41 & SBR41-LCR WIRING OPTIONS**Diagram 7 | SBR43-50 TO SBR43-85 WIRING**

Wiring Connection

Once the mounting screws are installed and the wire hole has been drilled, it is time to run the wires.

Each soundbar will have an individual pair of speaker wires for each speaker:

Diagram 5: The SBR41 & SBR41-LCR models will have 1 pair of wires to connect to the single speaker, and can be mounted each as either a Left, Center, or Right speaker.

Diagram 6: The SBR43-50 - SBR43-85 range of models will have 3 pairs of wires to connect to the each of their 3 internal speakers.

Each pair of speaker wires will have a positive (+) and negative (-) connection. Check your speaker wire for the indication along the wire to differentiate between the two. Make sure you use the same wire to connect to (+) and (-) on both the speaker and the amplifier/receiver.

Strip the insulation ½” from the end of the wire. Run the speakers out of the hole in the wall and use the connectors to attach the correct wires to the speaker terminals. The terminals operate by putting the wire inside the terminal. After the wire is inserted, use a screwdriver to turn the screw, and it will lock the wire in place. Lastly, make sure the insulation is not inserted into the hole in the terminal as it will not allow the wire to make a connection.

NOTE: On the SBR41 & SBR41-LCR models, ensure you connect the appropriate channel, Left, Center and Right, on both the speaker and the amplifier/receiver. If not, the positional steering of the movie soundtrack will be incorrect.

(See *Diagram 8*).

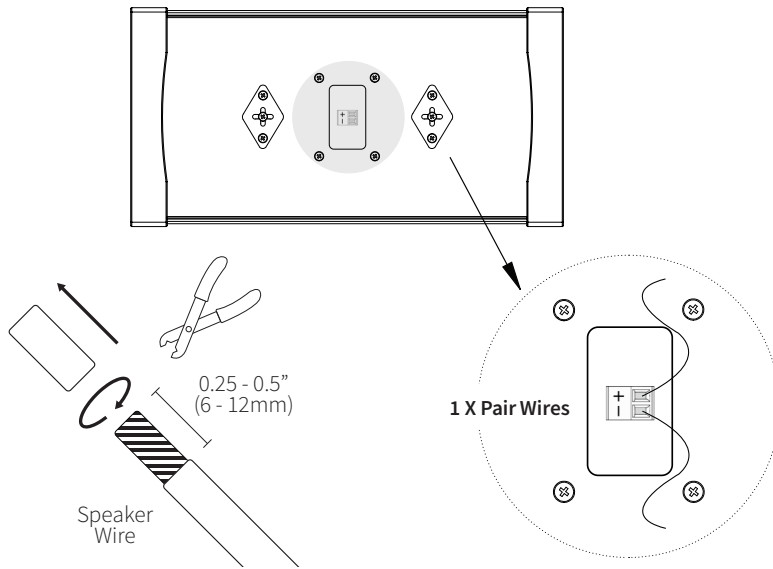
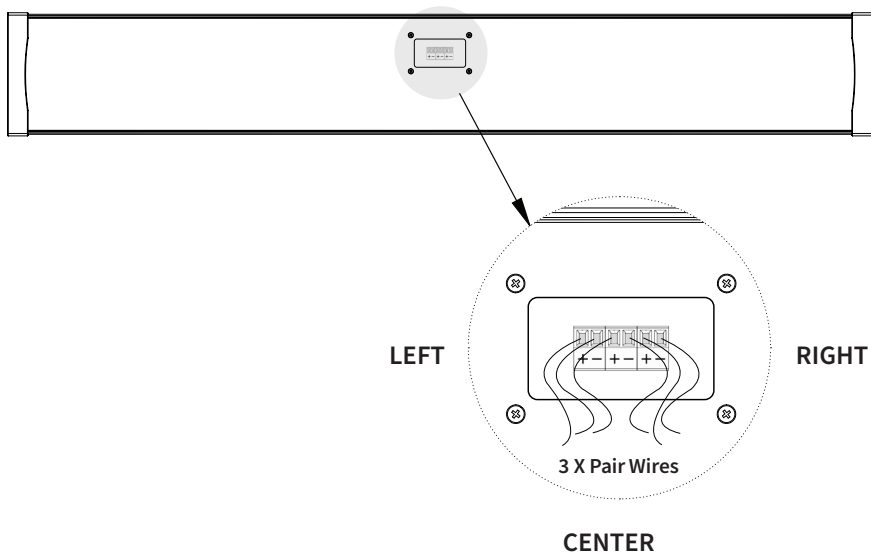
Diagram 8**• SBR41 & SBR41-LCR WIRING WITH SINGLE PHOENIX CONNECTOR****• SBR43-50 TO SBR43-85 WIRING WITH 3 PIN PHOENIX CONNECTOR****Finalizing the Installation**

Once the speaker has been wired, secure the Soundbar to the wall by sliding it over the screws. Make sure to feed the wires into the wall as you prepare to mount it to avoid pinching, kinking or disconnection during the mounting process. Your new Soundbar is now ready for your listening enjoyment.

Perfecting the Sound

Depending on the complexity of your system, there are several possible adjustments to provide the best possible sonic experience:

Most audio/video receivers (AVR's) have some type of test program that plays a signal through each channel to allow you to balance the output. This is best performed from the principle listening position.

There will also be equalization (EQ) controls to adjust the frequency response as it is effected by the parameters of the room.

If you are using a dedicated subwoofer, adjusting the balance and crossover point between the subwoofer and your Soundbar is critical; the ideal balance will provide deep warm bass without overshadowing the mids and highs that are so critical in a musical performance. This may take a few days and several small adjustments to get it right.

Lastly, be aware that different sources, BluRay Disc Players, Cable TV, streaming music will all have slightly different volume levels and EQ curves. Even different television channels may vary in their sonic presentation. This is normal and something you can adjust to your preference.

Troubleshooting

If possible, it's often good to try to isolate the problem first. For example, if you're playing a DVD on a television and there's no sound, try connecting an MP3 player to the system to see if that works. If it does work, then the problem is with the television, DVD player, or the cables connecting them. If it doesn't work, the problem will be with the amplifier, speakers, or those cables.

Problem	Possible Cause
No Sound	The volume may be turned down or muted. Check the volume settings on both the amplifier and the television/computer/CD player/etc.
No Sound	Make sure the proper source is selected on the amplifier or receiver.
No Sound	Check the cord connecting the amplifier with the source. The cord may be damaged or plugged into the wrong input or output.
No Sound	Check the wires connecting the amplifier with the speakers. Make sure they're connected properly and not damaged in any way.
Poor Sound Quality	If you hear something like static, or the sound is cutting in and out, check the audio cables. If the problem increases when a cable is being moved, then the cable is most likely faulty or not connected properly.
Poor Sound Quality	Today's audio systems may have several places to adjust the volume, for example your MP3 player may have a volume control, and your amplifier may also have one. Check to be certain that the volume isn't turned up past 80% on any device.

Technical Assistance

If you have any questions or concerns about installing or using this product, you can reach us through one of the following methods:

Phone: (844) 674-4461

Hours of operation: 8:00am - 5:00pm (Pacific Time), Mon - Fri

Email: sales@originacoustics.com

If you are having technical trouble, please include the model number and briefly explain what steps you took to resolve the problem in your email, or be prepared to answer these questions over the phone. If you are considering returning the product, it's required that you contact Origin Acoustics prior to any return attempts. This way we can determine if the issue can be resolved without returning the product, or if needed we can provide instructions and support for the return process.

Warranty Coverage - 5 Year Limited Warranty

Origin Acoustics warrants to the original retail purchaser only that for a period of Five (5) years from the original date of purchase. This Origin Acoustics product will be free from defects in materials and workmanship, provided the speaker was purchased from an Origin Acoustics authorized dealer.

If the product is determined to be defective, it will be repaired or replaced at Origin Acoustics' discretion. If the product must be replaced yet it is no longer manufactured, it will be replaced with a model of equal to or greater value that is the most similar to the original. If this is the case, installing the replacement model may require mounting modifications; Origin Acoustics will not be responsible for any such related costs.

Requirements & Warranty Coverage

This warranty may not be valid if the product was purchased through an unauthorized dealer. This warranty only applies to the individual that made the original purchase, and it cannot be applied to other purchases. The purchaser must be prepared to provide proof of purchase (receipt). This warranty will not be valid if the identifying number or serial number has been removed, defaced, or altered.

***All warranties and warranty conditions are subject to change. Please refer to www.originacoustics.com for the latest information.**

Not Covered by Warranty

- Accidental damage
- Damage caused by abuse or misuse
- Damage caused by attempted repairs/modifications by anyone other than Origin Acoustics or an authorized dealer
- Damage caused by improper installation
- Normal wear, maintenance, and environmental issues
- Damage caused by voltage inputs in excess of the rated maximum of the unit
- Damage inflicted during the return shipment

Return Process

Before making any return attempts, it is required that you first contact Origin Acoustics. Return product to Origin Acoustics or your dealer, either in person or by mail. It's preferable if the product is returned in the original packaging. If this isn't possible, the customer is responsible for insuring the shipment for the full value of the product.

This warranty is in lieu of all other expressed or implied warranties. Some states do not allow limitations on implied warranties, so this may not apply depending on the customer's location. (For more information, see Magnuson-Moss Warranty Act.)



Rev A

6975 S Decatur BLVD, Las Vegas, NV 89118 • www.originacoustics.com • 844-674-4461

©2022 Origin Acoustics. All copyrighted, trademarked and patented elements mentioned herein are the sole property of Origin Acoustics.